

Unified Analysis of Aerospace Structures through Implementation of Rapid Tools into a Stress Framework

Craig S. Collier¹ and Stephen P. Jones²

Collier Research Corporation, Newport News, VA, 23606

Rapid structural analysis tools have become an important part of the design cycle for aerospace companies for the last several decades. As these tools have been developed over time, there is often little consideration for shared software infrastructure between the tools, which makes design and analysis cumbersome due to a lack of commonality in input and output data and reporting, as well as poor traceability of results. Under the Rapid Tools task of the Advanced Composites Consortium (ACC), four aerospace tools were recently implemented or enhanced in the HyperSizer stress framework and then evaluated by this consortium of industry and government organizations. The framework provides an automated software environment for executing the rapid tools for analysis and sizing, quantifying margins of safety for thousands of load cases, and generating reports in support of FAA certification. This paper describes the process by which the tools were enhanced or implemented in the stress framework under the ACC project, and the evaluation conducted by industry consortium members.

I. Introduction

Modern aerospace stress analysis is conducted using methodologies and tools with varying degrees of complexity. **M** Rapid computationally-inexpensive tools are frequently employed in the earlier stages of design and analysis where reduced cycle time and ease of operation are critical. During this phase of analysis, many hundreds or thousands of candidate designs may be evaluated for a given structural element, making more detailed analysis infeasible. As the design of an aerospace vehicle matures, the use of more detailed (but more computationally-expensive) methodologies may be employed for select failure modes, load cases, or regions of the structure. For example, during the design phase of a commercial aircraft wing, the postbuckling response of skin panels may be approximated by rapid tools such as the von Kármán effective width approach [1]. As the design is finalized however, more advanced nonlinear finite element analysis (FEA) may be employed to verify that the structure remains safe through the most critical flight loads.

In practice, rapid tools often remain in use throughout later stages of analysis supporting FAA certification as more advanced methodologies may be unavailable or impractical to apply and test data become available to validate the rapid tool results. OEMs report that more complicated analyses (e.g. FEM-based) are replaced by simplified, rapid methods over well-understood and often very narrow design spaces, limiting the need for complex, expensive FEMs.

HyperSizer® software was started at the National Aeronautics and Space Administration (NASA) and was commercialized in 1996 by Collier Research; it has been under active development to present [2]. Since starting as a

© Collier Research Corporation. Published by the American Institute of Aeronautics and Astronautics, Inc., with permission.

¹ CEO and President, Collier Research Corporation, AIAA Associate Technical Fellow

² Aerospace Structural Engineer, Collier Research Corporation, AIAA Member

commercial tool, many capabilities have been added to the original capability developed at NASA including rapid analysis of the postbuckling behavior of stiffened panels as well as a semi-analytical bonded joint solution. For the Advanced Composites Consortium (ACC), which is under NASA’s Advanced Composites Project (ACP), these tools have been extended. Although both tools had been previously verified and validated against limited publicly-available FEA and test data [3] [4], further verification and validation was completed under this program to broaden the applicability of the analysis [5].

Two additional rapid tools that were developed under the ACP project, residual compressive strength after impact (developed by United Technologies Research Center) and large notch residual strength (developed by the Boeing Company and Spirit AeroSystems), have also been implemented.

II. Consortium Evaluation

The overall goal of the ACC project was to reduce the design cycle time and testing of composite aircraft structures by 30%. This goal is partially met through integration of many analysis tools into a common framework. The HyperSizer integrated framework containing the four rapid tools was evaluated by the consortium’s rapid tools, 2C20 cooperative research team (CRT) to quantify reduced cycle time provided by the framework when compared to executing each tool in standalone modes.

- Cycle time reduced from months to days on average with the framework
- Executed composite failure analyses typically in 0.1 seconds
- Applied to hundreds of structural parts to hundreds of load cases
- Very good ratings for accuracy, traceability, and reporting by ACC members

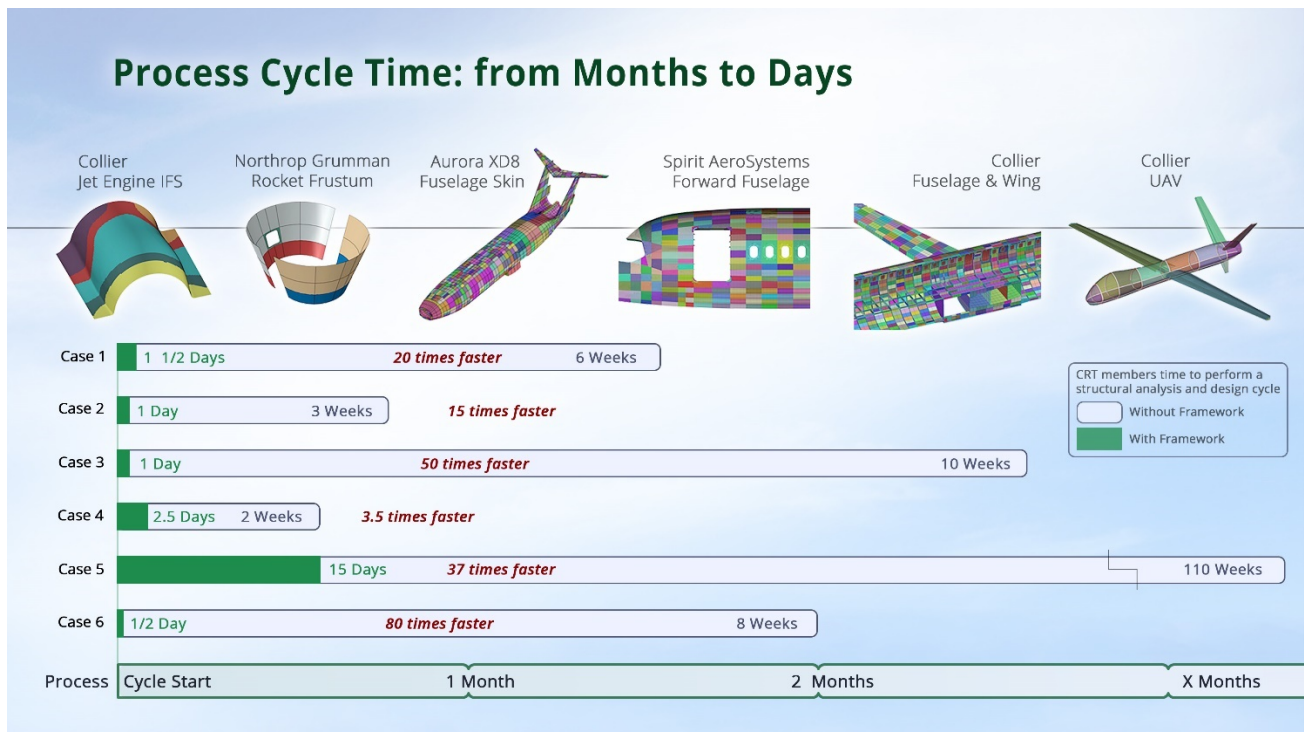

Fig. 1, Reduced time reported by ACC members by using the HyperSizer Stress Framework for their composite structure as compared to same process using the ACC members’ existing process.

Figure 1 summarizes the reduced design cycles times for each structure, associated FEM, and level of analysis and design sizing maturity. Other factors will allow only some of this substantial schedule reduction. However, reduced

cycle times provided by the framework automation will allow engineers to explore more design space and find more performant, lighter designs that are also easier to manufacture, with less defects, and hence less costly to produce.

ACC funding is targeted to aircraft, as such two consortium structural applications included in this paper are a representative commercial transport fuselage-wing, and a jet engine integrated fixed structure (IFS). These FEMs and other details are presented later.

III. Stress Framework

HyperSizer has evolved into software which is best described in general terms as an *engineering process framework*. As such it provides a standard way to build and deploy applications for structural design and analysis. In terms of the NASA ACC project it is being used as a framework for stress analysis using rapid tools. It provides generic functionality such as executing FEA while allowing users to implement additional user-written code. The framework code itself is not intended to be modified by the user, but to be quite general in accepting user-implemented extensions. It provides automation of user work flows with the ability to advance from one step in the process to the next, and if necessary, to backup or iterate previous steps without loss of data. All the while providing extensive analysis traceability and documentation.

In the context of this report, it's use is focused on the design, analysis, testing, traceability, documentation, and manufacturing process of advanced composite materials for airframe and jet engine structures. As a software tool [6] specializing in detailed stress sizing of stiffened panels and associated details (such as honeycomb core ramps and joints) many design details are included. As a stress framework, it provides a large amount of infrastructure to assist in the design and analysis of aerospace structures, such as:

- Standardized and consistent analytical analysis methods
- Material database containing allowables, stiffnesses, etc.
- Automated FEA load extraction, transformation, and processing including filtering and identification of critical conditions
- Sizing of metal and composite structure, both stiffened and unstiffened
- Global FEM management
- Iteration with FEA for load path convergence, deflection limits, and global buckling requirements
- Data exchange with external tools such as CAD packages

The framework is designed to be deployed at an enterprise level and implemented in a standardized way within one or many stress groups. The features it provides allow for consistent and repeatable results to be generated by practicing stress engineers within an organization. This process has previously been demonstrated within aerospace original equipment manufacturers (OEMs), but only limited publicly-available documentation on the process and results are available.

Analysis methodologies and failure criteria are a major consideration for structural design. The stress framework includes a wide variety of failure criteria natively such as conventional and bonded joint specific composite strength criteria [7], as well as more complex methodologies such as the postbuckling [8a] [8b] and bonded joint [9] routines. Additional (custom) analysis criteria may be added to the software using “analysis plugins”, as described in section VII.

IV. Verification and Validation

The four rapid tools were verified and validated by the ACC over the three-year project. Validation testing took place at the National Institute for Aviation Research (NIAR) and NASA Langley Research Center. Verification to other solutions provides insight into the limits of their applicability. Calibration to the tests provide factors to apply

for required conservative accuracy. Together they provide the user with knowledge for their consistent, robust, and accurate use for design sizing and analysis development leading toward subsequent FAA certification.

Table 1. Summary of Rapid Tool Validation Tests

Rapid Tools Validated	Accurate to	Testing 2019
2-Bay Crack: Open-section	±10% for 75% tests	Boeing historical compression/tension tests
2-Bay Crack: Closed-section hat panel	-26% tension/ -8% compression	CRT funded NASA Langley 2 tests
BVID/CAI: Tape and plain-weave	±30% for 100% tests	CRT funded NIAR 41 tests
Bonded Joint: Bonded Joints	-10% for 90% low scatter tests -20% for 80% high scatter tests	CRT funded NIAR 118 tests
Postbuckling: Closed-section hat panel	±3% for 100% tests	CRT funded NIAR 4 tests
Ply Drop: Tape and plain-weave	-30% for 90% tests	CRT funded NIAR 53 axial-bending tests

V. FAA Certification

Table 1 test data represent some of the essential tests to perform in the building block pyramid process that goes from small coupons to full scale airplane static tests. The goal of the ACC is to improve and shorten the timeline required to achieve FAA certification. As the ACC was a 50% cost share with industry members, these structural types and intended failure modes were defined collectively by the consortium and are arguably most important to address for certification of composite aircraft today.

Aircraft structural airworthiness FAA certification is premised on the company’s ability to prove that the airframe is safe. It is not the FAA’s purpose for airplane manufacturers to achieve light performant aircraft. The competitive market and consumer willingness to pay will motivate this cause. And it’s not FAA’s purpose to certify software. The FAA’s purpose is to approve type certification to an aircraft based on the company showing a complete trail of documentation proving structural integrity. When manufactures approach the FAA, they need to have a strategy and approach for consistent design practices that support manufacturing developments in a way that minimizes manufacturing anomalies and keeps part consistency. That is easier said than done. The company needs to show the FAA their specific analysis to production process that achieves this. There is no cookie cutter way to do this, and so the FAA provides leeway for a manufacturer to determine their own ‘proof’.

For this reason, a stress framework used to support certification must allow the aircraft company using it to incorporate their own design data, sizing methods, guidelines and criteria. The company will define guidelines and criteria to constrain the design space, minimizing the cost of structural data for composite strength and damage tolerance efforts, which have semi-empirical relationships. Without constraints put into place, as the design matures it may make the design/stress tasks difficult and may require significant nonrecurring investments.

FAA efforts are intended to ensure certification requirements are met and a reproducible product can be controlled after demonstrating proof of structure and other regulations. To support this life cycle, a stress framework becomes the equivalent of electronic stress notes that can quickly deal with future challenges and product updates, including advancements to derivative aircraft (load changes) and structural modifications (design detail changes). And there is also a need to go back in time, to be able to roll back to a version and use the software along with associated input data and repeat the analysis and produce the same margin results.

The rapid tools of Table 1 are integrated into the framework as either native or plugin.

VI. Native Methods

The software natively includes a wide array of industry-standard analytical material strength and stability criteria. Under the Advanced Composites Project, emphasis was placed on verifying, validating, enhancing, and demonstrating the use of two analysis routines: bonded joint and postbuckling, both of which are considerably more advanced than typical aerospace analytical methodologies but retain the high performance necessary to be considered a rapid tool. The below sections provide a brief overview of the tools.

A. Bonded Joint

The HyperSizer bonded joint analysis tool is fundamentally based on Mortensen's unified approach, but has been significantly extended and has been implemented within the HyperSizer stress framework software since 2005. The methodology is formulated using plate theory kinematics, classical lamination theory (CLT), traction-separation equations in the adhesive, assumed cylindrical bending displacement fields in the adherends, and direct application of equilibrium between zones. Adhesive material behavior may be treated as linear or nonlinear, using the Ramberg-Osgood formulation for the latter.

The system of ODEs is solved numerically, yielding laminate-level fields and adhesive stresses along the entire length of the joint. In-plane ply stresses and strains are calculated using Classical Lamination Theory (CLT). Out-of-plane (interlaminar) stress components are computed via through-thickness integration of the equilibrium equations. The full process of determining ply-by-ply three-dimensional stresses and strains has been previously documented in full [9,10].

The simplifying assumptions inherent in this methodology result in a highly efficient tool; typical execution time is in the range of a tens to hundreds of milliseconds. This speed enables the tool to be used for both analysis and sizing when there may be tens of thousands of load cases and hundreds or thousands of unique joints in a large aerospace model.

In addition to assessing the strength of bonded joints using stress- or strain-based failure criteria, the virtual crack closure technique (VCCT) was implemented in the HyperSizer bonded joint analysis tool in 2006. Although the HyperSizer bonded joint VCCT analysis capability is semi-analytical as opposed to the typical FEA-based implementations, it follows the same basic assumptions and process as its finite element equivalent. A pre-existing crack is included in the bondline of the model, and the work required to close the crack by an incremental Δa is used to compute the strain energy release rate.

VCCT has been used to supplement or replace stress-based failure criteria in composite bonded joints in the aerospace industry for a variety of reasons, including:

- VCCT is less sensitive to small model changes (or mesh density in the case of FEA) than stress-based criteria, because it is based on energy rather than stress
- Certification often requires that original equipment manufacturers (OEMs) account for potential defects in bondlines due to manufacturing flaws or in-service damage
- Required material properties are usually well-characterized through standard testing (critical strain energy release rates)

In summary, the method applies to a variety of joint configurations, arbitrary composite laminates and adhesive materials. The user can choose stress-based criteria with nonlinear adhesive or energy-based fracture mechanics (VCCT) and put in any bond line crack length. Runtime: ~0.1 seconds, making it practical – designed for the everyday stress engineer.

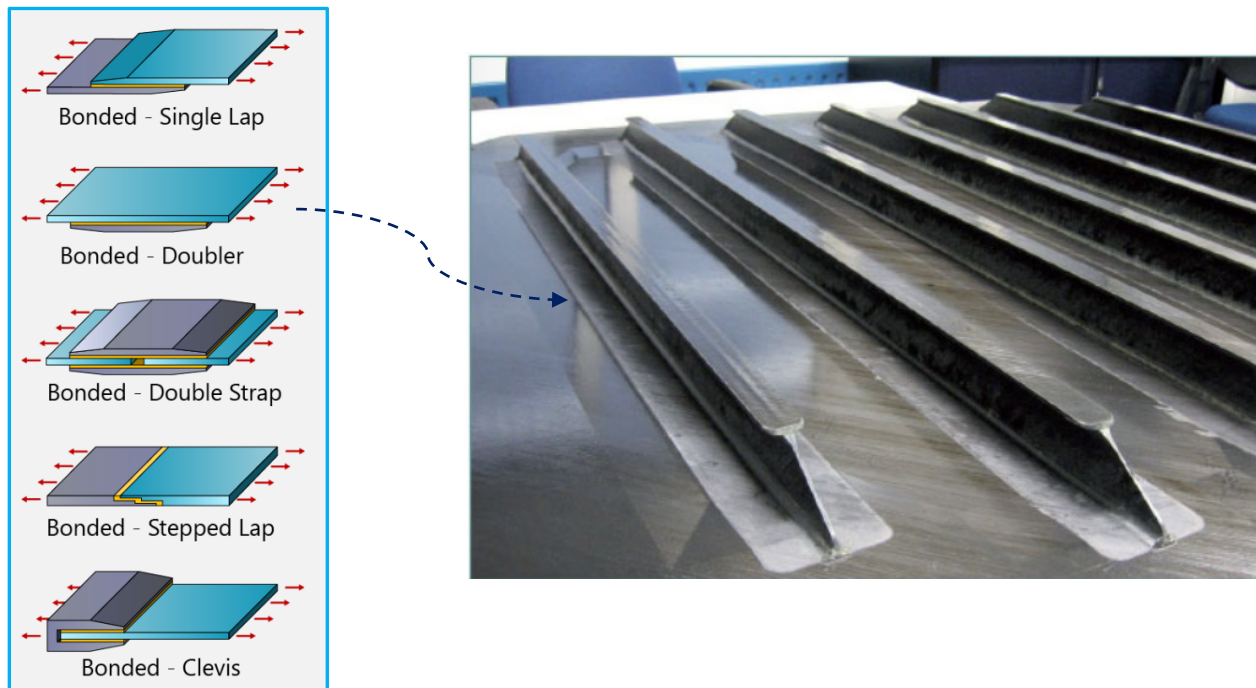

Fig. 2, A stiffened panel, bonded doubler joint, of the attached flange to skin.

Test articles were manufactured and tested by the National Institute for Aviation Research (NIAR) in Wichita, Kansas in 2019. A variety of joint configurations were tested, and predictions generally agreed well with experimental results; the median error compared to test was on the order of 10-15%. A total of 108 bonded joint specimens were manufactured and tested. 81 had embedded cracks and 27 had pristine bondlines. The specimens consisted of:

- Single Lap – 35
- Bonded Doubler – 21
- Scarf – 6
- Double Strap – 10
- Hat Stiffeners – 24
- Tee Stiffeners – 3
- Bonded Spars – 3
- Scarf-Repaired Laminates – 6

An output of this verification and validation exercise is a series of derived calibration factors to reduce the probability of unconservative predictions. These factors were derived from finite element results as well as test data; the processes used to derive them could be repeated for bonded joints manufactured by any OEM to determine how they may change based on joint configuration, their specific manufacturing technology, etc. Table 2 shows correction factors based on finite element data, Table 3 shows factors based on tests exhibiting low scatter between specimens, and Table 4 contains factors for tests exhibiting high scatter. These test results are from test specimens with embedded bondline cracks of 1/2" inch.

Table 2: FEA Correction Factors

Suggested Correction Factor	Probability of Conservative Result
1.0 (None)	41%
0.9	82%
0.8	92%
0.7	96%

Based on 2400 finite element models of different loads and joint configurations

Table 3: Test Correction Factors for Low-Scatter Test Results

Suggested Correction Factor	Probability of Conservative Result (Low-Scatter)
1.0 (None)	44%
0.9	78%
0.85	100%

(C.V. \approx 10%)

Table 4: Test Correction Factors for High-Scatter Test Results

Suggested Correction Factor	Probability of Conservative Result (High-Scatter)
1.0 (None)	50%
0.85	57%
0.5	79%

(C.V. $>$ \sim 25%)

Summarized test data from Table 1 is more fully defined in Tables 3 and 4. If its expected that joint failure loads, for a given configuration, will be repeatable with low scatter, then Table 3 is appropriate to use. In this scenario a correction ‘knockdown’ factor of 0.9 would achieve conservative results 78% of the time, and a .85 factor would cover 100% of the cases. These factors can be substantiated with comparison to FEA. For our purposes data in Table 2 was generated to establish the limits of applicability of the analytical solution to many different configurations and loadings. Note, some of the FEA solutions are suspect since the meshes and model setup were automatically generated without visual inspection of every run.

A joint’s loading, design, and fabrication technology could produce a wide difference in measured failure loads, high scatter, for the same configuration. In this scenario Table 4 may be appropriate to consider. These high scatter results can be addressed by an OEM with improved fabrication quality and consistency. Reasons for high scatter for this group of tests range from test grips slipping, to adhesive thickness variation along the bond line caused by hand applied material and processes with paste bonds. High test scatter is not an analysis inaccuracy consideration.

The remedy and need for certification are to have the OEM use their well refined production process that will more likely produce repeatable quality joints. And from these perform their own testing. Based on their observed test scatter they could then apply their own derived correction factors to account for their needed conservatism to test scatter. This correction factor could be defined separately from, and added to a correction factor that strictly addresses the test average difference to analysis predictions.

These factors from the Tables are used during sizing of the fuse-wing FEM presented later.

B. Postbuckling

The HyperSizer stress framework software contains a rapid analysis capability for predicting the behavior and ultimate collapse strength of stiffened composite panels under compressive and shear loading. This methodology was verified against nonlinear finite element analysis and was demonstrated to accurately predict the stresses in the cross-section of a variety of stiffened panels under uniaxial compression postbuckling to within 5% on average.

The rapid tool implementation uses a convergence algorithm to dynamically calculate effective width based on applied loading, figures 3 and 4. This approach is unlike most analytical solutions to the problem such as the von Kármán effective width approach that assigns a constant effective width independent of the actual load.

Test panels were fabricated by Spirit AeroSystems and tested by the National Institute of Aviation Research in Wichita, Kansas in May 2019. The rapid analysis tool was used to generate a pre-test prediction for a hat-stiffened panel under uniaxial compression. The skin buckling load was predicted to within 8% of test average (test coefficient of variation = 7.3%).

The tool's prediction for crippling of a single hat stringer segment was 4% of the test average, with small test scatter as seen with the height of the vertical bars in figure 5.

The tool's prediction of postbuckling collapse of a four stringer stiffened panel was within 1% of the test average, with a very small test scatter with a coefficient of variation (C.V.) = 1.7%). The ultimate postbuckling load-carrying capability of the test panels at collapse was nearly 300% the load that caused initial skin instability, demonstrating the potential for increased performance and decreased weight of structures designed to undergo postbuckling.

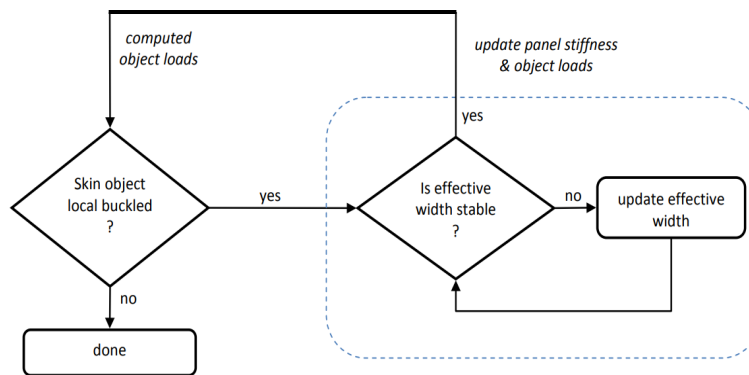

Fig. 3, Iterative convergence of the effective width from the start of skin buckling bifurcation to the end of Postbuckling collapse.

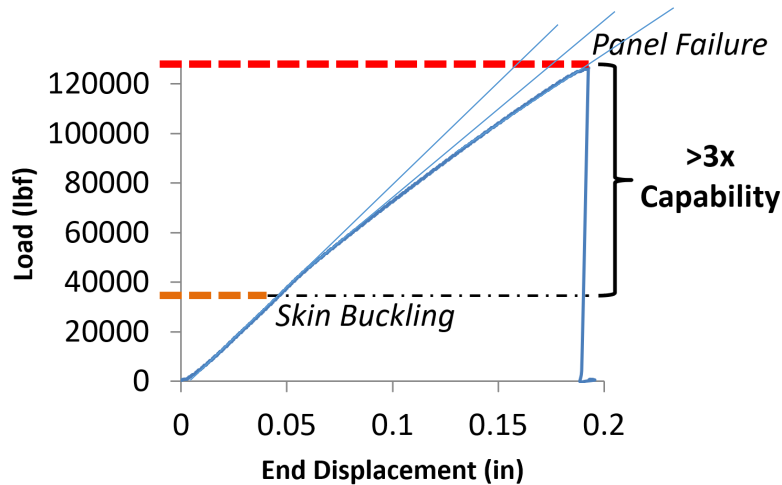

Fig. 4, Load vs displacement response from test showing the reduced panel stiffness as the effective width narrows from skin buckling to panel collapse at 300% more load.

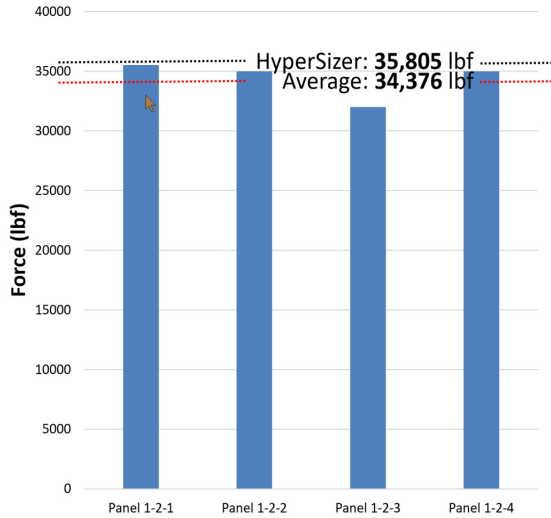

Fig. 5, Single stringer crippling test data from NIAR testing 2019 with low scatter and ultimate collapse load analysis prediction to within 4% of test average.

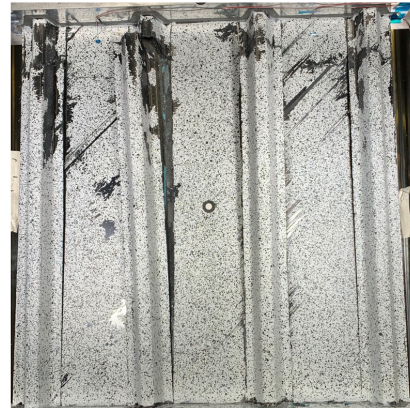
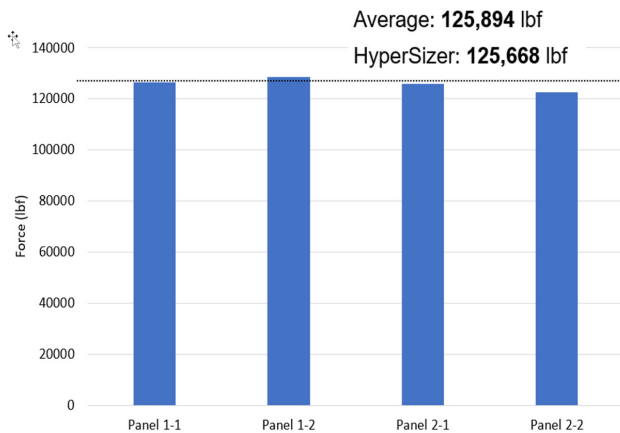

Fig. 6, Four hat segment stiffened panel postbuckling test data from NIAR testing 2019, with very low scatter and ultimate collapse load analysis prediction to within 1% of test average.

Caveats: The bonded joint tool analyzes the strength of the bond line between the stringer attached flange and skin. Adhesive nonlinear properties are used to compute out of plane peel and interlaminar stresses at prescribed characteristic distances to predict failure. Cracks can be prescribed as well in the adhesive to perform VCCT analyses. Both analyses are performed at limit and ultimate applied loads. However, if the skin is allowed to buckle below ultimate load, then the resulting out of plane mode shape (localized curvature in the laminate) will cause likely higher stresses that are not considered. Internal pressurization of a fuselage could cause the stringer to roll also not captured.

Figure 7 shows margins of safety (MS) for different failure modes. $MS = (\text{allowable}/\text{applied} - 1)$. The critical MS is **0.017** for skin buckling at 50% limit load. A required $MS = -0.5$ is input by the user, and the resulting $MS = -0.492$ becomes 0.017 satisfying the required $MS > 0$. The next red box in the figure highlights the critical margin at 150% limit load which is **0.014** for crippling-buckling interaction. The next lowest is CAI strength = **0.052**. Therefore the 1st three failure modes are within 5% of requirement.

Since the critical margins = 0.017 at 50% limit and = to 0.014 at 150% limit, this shows a 300% increase in postbuckling collapse load. The effective width 5.28" at limit load becomes narrower to 4.10" ultimate collapse.

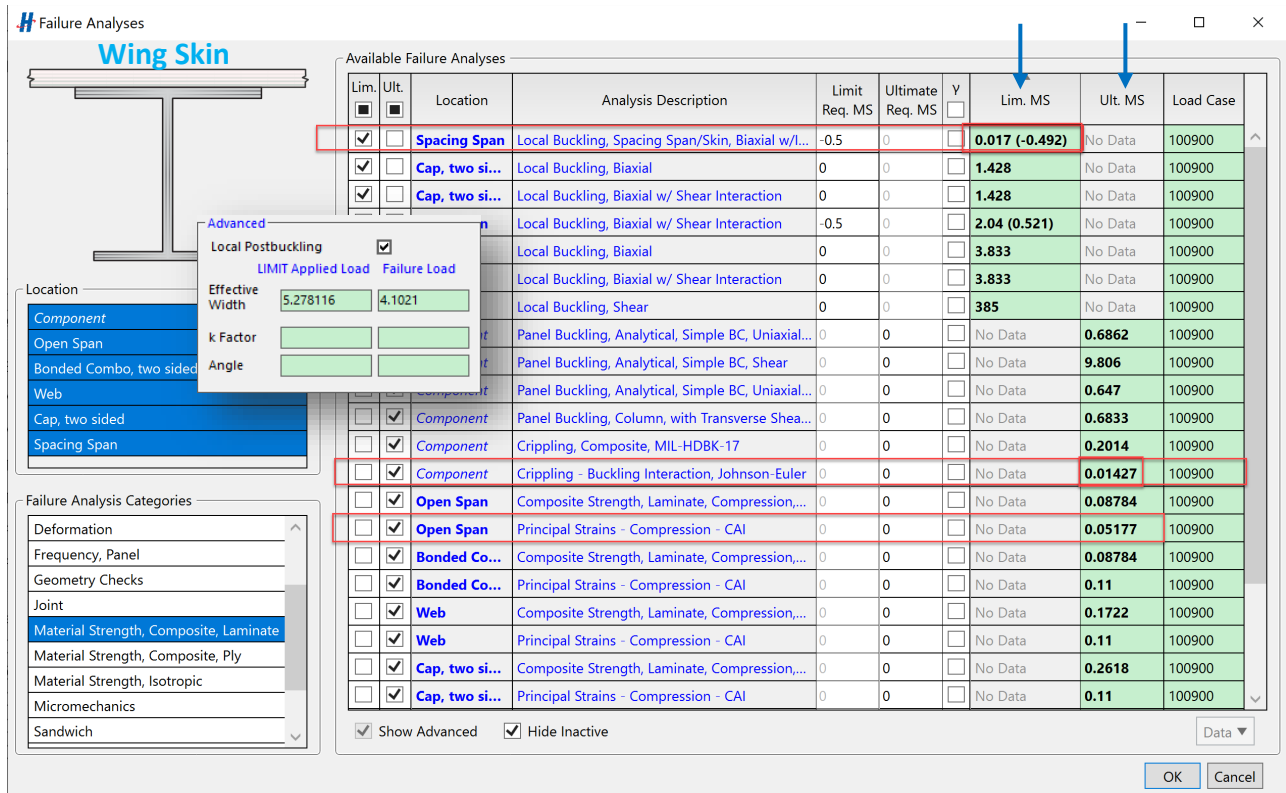

Fig. 7, Failure tab display of limit load margins in left column, ultimate in right column per analysis method.

VII. Plugin Methods

The stress framework provides an API to “plug in” custom analysis criteria in addition to those that are natively included. This capability is primarily used by end users to supplement basic aerospace strength and stability criteria with those that are proprietary or specific to a program or company [11]. Analysis plugins conduct analysis fully outside of the main software, but are automatically provided required data such as geometry, material properties, allowables, and loads. The plugins then return margins of safety that are used for detailed sizing and analysis. Two plugin methods were developed and implemented under the ACC project.

Rather than being included as native capabilities, the analysis software for residual compressive strength after impact, CAI (developed by United Technologies Research Center, UTRC) and large notch residual strength (developed by the Boeing Company and Spirit AeroSystems), were implemented as “analysis plugins” through the plugin application programming interface (API).

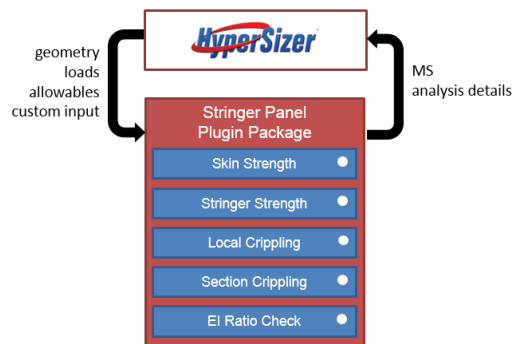

Fig. 8, Example of an analysis plugin package, complete with data transfer and several analysis criteria

A. Barely Visible Impact Damage (BVID) and Compression After Impact (CAI)

A stand-alone tool for predicting low-velocity impact damage in polymer matrix composites and the corresponding residual compressive strength was developed by United Technologies Research Center (UTRC) under the ACC project [12]. In the present work, this stand-alone tool has been implemented into the stress framework using the analysis plugin API.

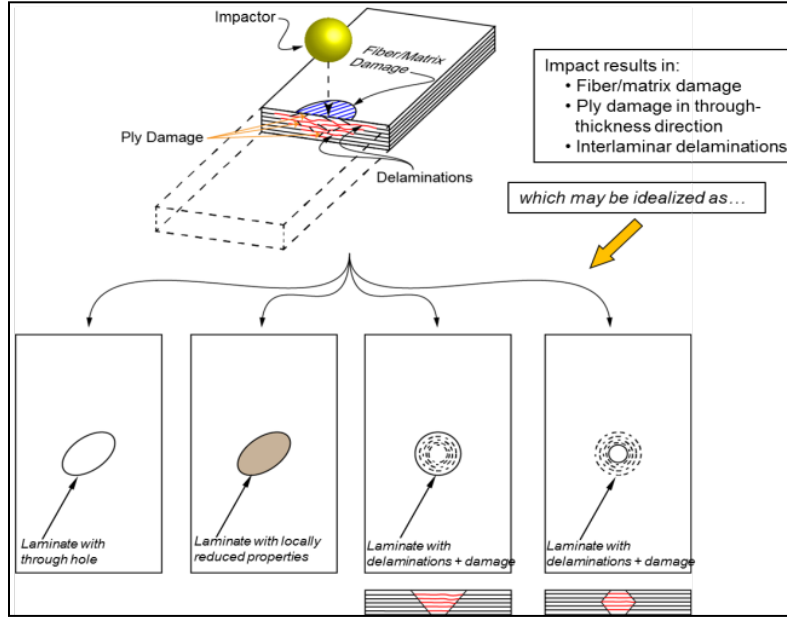

Fig. 9, UTRC's integrated impact and resulting BVID CAI residual strength tool.

Impact resistance and subsequent reduction in residual strength are key properties needed for initial sizing and design of aerospace polymer matrix composite (PMC) structures. Compression after impact (CAI) strength is of particular interest because of the significant reduction in compression strength due to impact. Typically, these properties are measured experimentally for each laminate configuration under consideration for design. Because of the large number of parameters defining the material such as laminate configuration (e.g., layup, ply thickness, fiber architecture) and impact scenario (e.g., impactor radius, mass, energy), performing tests for every possible combination is intractable – time consuming and prohibitively expensive. Therefore, a small subset of combinations, typically based on past design experience, is tested and the results used for developing design allowables and/or design optimization. This approach inherently limits the design space and may result in sub-optimal design choices early in the design process and/or incorrect design decisions that can lead to expensive redesigns later on in the process. Given the limitation of current experimental and simulation methods in sufficiently populating a design space for laminate configuration optimization, a comprehensive, rapid BVID/CAI modeling framework was developed.

The rapid analysis framework consists of two sequentially coupled steps – BVID prediction followed by CAI strength solution. Coupling the rapid CAI strength model developed in [13] with the BVID model from [Borkowski et al., 2020] yields a comprehensive tool spanning impact to compressive residual strength. Each of the component models (BVID and CAI strength) are composed of multiple modules simulating various physical mechanisms such as the plate transient response to impact, damage initiation and propagation during impact, and sublaminar buckling and kink band propagation under compression.

The original standalone Fortran code was developed to read an ASCII file rather than accept arguments through memory, as is typical for most plugins. Therefore, a process was developed in C++ to export an ASCII input file automatically for each panel design candidate being analyzed. Although the runtime of this tool is on the order of seconds rather than milliseconds, efficient use was achieved by computing the residual strength of a given laminate only once, and re-computing the margin of safety for each load case using this stored value as,

$$MS_{CAI} = \frac{\sigma_{CAI}}{\sigma_{applied}} - 1$$

B. Large Notch Two-bay Crack Residual Strength

“The Two-Bay Crack Analysis Tool Collaborative Research Team (CRT) member leads are Boeing [14,15] and Spirit AeroSystems. Two-bay notch analysis capability is of particular interest to airframe designers because certification requirements of commercial aircraft requires that a catastrophic system failure due to accidental damage be avoided. This requirement is codified in 14 CFR 25.571, with guidance on compliance provided in FAA Advisory Circulars AC 20-107B and AC 25.571-1D (Ref No. [9] [10]) the former of which is specific to composites. The kind of damage associated with this requirement is often referred to as “discrete source damage” and is a critical aspect of design solutions associated with each part of the structure that could contribute to catastrophic failure. Examples of this damage may include rotor burst, bird strikes, tire bursts, and severe in-flight hail. Discrete source damage may also be associated with an event that is known to the flight crew such that flight maneuvers are limited. A typical method of compliance is to demonstrate that a structure can carry load with a severed principle structural element (PSE) and associated structure.

In practical commercial airframes made of composites, the discrete source damage requirement can dominate the design over much of the acreage, especially in fuselage structure. Thus, it is imperative to have tools to rapidly assess the damage strength early in the product development phase of an airplane program to minimize and or avoid costly redesigns and unplanned test programs. The closed and open section Two-Bay Crack tools are designed to handle pressure and curvature effects, circumferential short and long cracks, fuselage/wing structure, open/closed section stiffeners, thin and thick gauge structure, and a preliminary ability to assess susceptibility for a crack to turn. The capability includes an ability to predict stringer disbond failures and stringer breaking modes under tension and compression loads for an explicitly defined design space over which the tools are valid.”¹ Figure 10 shows an inserted crack in the center of a hat stiffened, composite four stringer panel and resulting failure scenario.

Unlike the BVID-CAI tool, the standalone version of the large notch tool was developed as a Fortran code which accepts arguments through memory rather than an input file; therefore, implementation of this tool was more conventional than the former.

As the analysis plugin API is written in C++, a “wrapper” was developed to allow data transfer between the two languages. This wrapper was designed to marshal data between the two codes through memory for maximum efficiency and minimum overhead. The Fortran dynamic link library (DLL) is loaded into memory by the C++ wrapper and executed repeatedly for all panel design candidates and load cases during the sizing or analysis process before being unloaded.

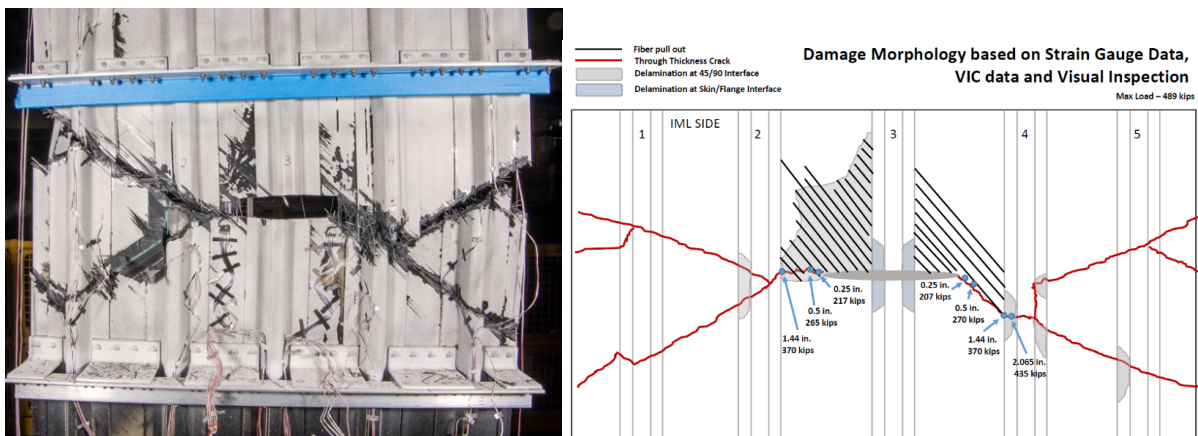

Fig. 10, Two-Bay crack testing at NASA Langley 2019.

¹ This content has been provided by The Boeing Company and Spirit AeroSystems.

VIII. Fuselage-Wing

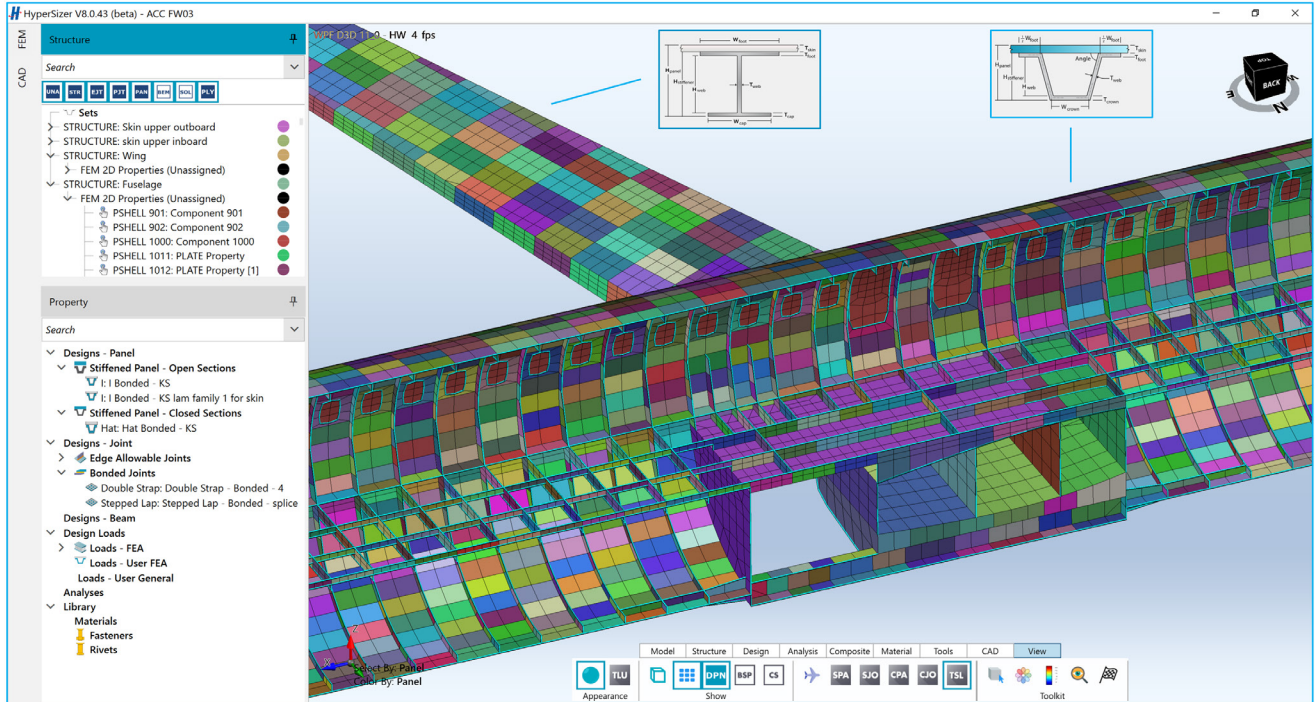

Fig. 11, The HyperSizer Stress Framework software interface.

The fuselage is a hat shaped composite stiffened panel concept and the wing skins are an I shaped composite stiffened panel concept.

A. Framework Challenge

This structure and resulting FEM have the most panels and joints of any other NASA Advanced Composite Consortium used structure. It includes the fuselage skins, frames, and floor beams; the wing skins, spars, and ribs, and the wing carry through structure. As such it challenges the stress framework's ability to handle large data sets and provide efficient display and data management for the engineer.

Table 4 itemizes the counts of panels and joints. There are **1459** stiffened panels of hat, I, and Tee concepts. For each panel, the user could choose to perform the following ACC rapid tool analyses:

- Two-Bay Crack large notch damage strength
 - 2Bay Crack analysis developed, verified, and validated by Boeing and Spirit AeroSystems.
 - A large notch crack that crosses over a severed stringer (and resulting margin) for fuselage skin Hat and wing skin I shaped composite stiffened panels. During sizing the proportion of stiffness between skin and stringer is varied to find an optimum panel. Some of the combinations may cause either a similar and non-similar crack growth.

Table 4. Representative Commercial Airframe, Fuselage-Wing counts of structural types.

Structure Type	Location	Count	Subtotal	Total
Stiffened Panels – Tee	Wing Carry Through	3	83	1359
	Wing Front and Rear Spar	53		
	Wing Ribs	27		
Stiffened Panels – I	Wing Skin Bottom	52	170	
	Fuselage Flooring	1		
	Wing Skin Top Carry-through	1		
	Wing Skin Top	116		
Stiffened Panels – Hat	Fuselage Forward	350	1106	
	Fuselage Center	319		
	Fuselage Aft	325		
	Fuselage: Forward Center Joint	56		
	Fuselage: Center Aft Joint	56		
Unstiffened Laminates	Fuselage Forward	13	1459	1459
	Fuselage Center	15		
	Fuselage Aft	12		
	Fuselage: Ring Frames	1117		
	Fuselage: Floor Beams	302		
Joints – Bonded	Fuselage: Forward – Center Joint	24	1591	
	Fuselage: Center – Aft Joint	24		
	Ribs	31		
	Fuselage: Forward – Stringer Segments	394		
	Fuselage: Center – Stringer Segments	358		
	Fuselage: Aft – Stringer Segments	365		
	Wing: Skin Top – Stringer Segments	230		
	Wing: Skin Bottom – Stringer Segments	165		
Joints – Edge Allowable	Fuselage Forward	375	1181	
	Fuselage Center	352		
	Fuselage Aft	350		
	Rear Spar	52		
	Forward Spar	52		
Joints – Fastened	Fuselage Forward	375	1304	
	Fuselage Center	352		
	Fuselage Aft	350		
	Wing Cover Top	51		
	Wing Cover Bottom	51		
	Ribs	24		
	Rear Spar	49		
	Forward Spar	52		
Joints – Riveted	Wing Bottom Cover	3	27	4103
	Fuselage: Center – Aft Joint	24		

- Postbuckling
 - Postbuckling verified and validated by Collier
 - Skin buckling load (and resulting margin) and the collapse postbuckling load (and resulting margin) for fuselage skin Hat and wing skin I shaped composite stiffened panels.
 - For postbuckled skin and resulting out of plane mode shape that causes localized curvature and changes (likely detrimental) to the peel and interlaminar Z axis stresses, engineer can choose to apply a conservative required margin > 0.0 to the bonded joint analysis of the stringer segment flange to skin.
- CAI damage strength
 - Method, verification, and validation by UTRC
 - Generate damage BVID laminate strengths for small diameters of approximately 0.5", 1.0", and 1.5".
 - Back out correction factors to multiply pristine allowables to arrive at CAI allowables.
 - Use The CAI corrected allowables to perform failure analysis and sizing

There are 1459 unstiffened laminates. For each the user could choose to perform following ACC rapid tool analyses:

- CAI damage strength

There are 4103 joints, of which 1591 are bonded (most being the bond of the stringer segment flange to skin) and 1304 fastened. The remaining are riveted or edge allowable joints. For the 1591 bonded joints which are either stiffened panel stringer segment type or traditional type, such as section 41 fuselage construction joint that can be evaluated as either a stepped single lap, or double lap; the user could choose to perform the following ACC rapid tool analyses:

- Bonded joint using two approaches:
 - Undamaged bond line using nonlinear adhesive analysis to compute out of plane peel and interlaminar stresses using a characteristic distance to predict failure.
 - VCCT with any crack length

Fuselage construction joints in-service today are fastened. For this reason, these same joints on the FEM are analyzed and sized with fasteners, as a baseline comparison. For the **1304** fastened joints the user could choose to perform native rapid tool analysis:

- Fastener analysis
 - including laminate bearing and bearing by pass stresses.

In summary, for the Fuse-Wing FEM, one loadcase requires approximately 1500 analysis calls to each of the four rapid tools. Though the number of primary loadcases are about 20, there are thousands of loadcases that must be analyzed eventually. In the span of a five year preliminary design phase these analyses will likely be performed hundreds of times as new external loads are 'dropped' on the stress group, or due to a change in design requirement, or change in material allowable, etc. A conservative count of how many analysis calls to each rapid tool would be made is then:

$$3 \text{ million } (1500*20*100 = 3,000,000)$$

If you include the use of the tools for a one time sizing optimization, and assuming on average about 500 candidates being evaluated per panel or joint design, then the count of analysis calls to each rapid tool would be made is:

$$15 \text{ million } (1500*20*500=15,000,000)$$

Assuming 0.1 sec for both the postbuckling and bonded joint analyses, this is 0.2seconds, and since the CAI is pre-executed to derive allowables, and the two bay crack is super fast, all four rapid tools can be executed together 5 times

in one second. If running on a multiprocessor computer, the effective amount of speedup is about 6, so then the four rapid tools can execute 30 times in one second.

Calculating the time it takes an engineer to interactively analyze and size the complete fuse-wing FEM is approximately 3 work weeks, or about 15 work days. Note, an engineer can continue to use the framework interactively while analyses are running in the background.

$$15,000,000 / (30 * 60 * 60 * 10 * 5) = 2.8 \text{ work weeks.}$$

This is for one FEA load cycle iteration. However, in practice for a project of this size, there would be hundreds of engineers working with different parts of the structures assigned to them. And presumably all using a stress framework.

To accomplish the same breadth and depth of analysis detail and design sizing by one engineer using spreadsheet implementations of the rapid tools would take an estimated 110 weeks.

B. Value of Framework: Unified Analysis

The computational speed of execution of the rapid tools is just one piece of a framework's duties. On the preprocess side, handling large quantities of data, passing this data consistently to the tools, and to visualize this data is required as well.

Small Crack in the adhesive at corner of a stiffened Panel

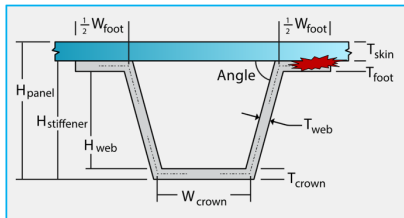

Large notch Two-Bay Crack through the laminate skin and stringer

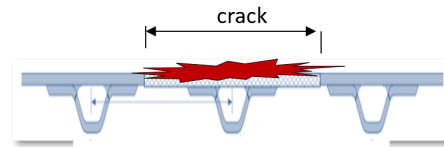

Or in in construction joints like single lap

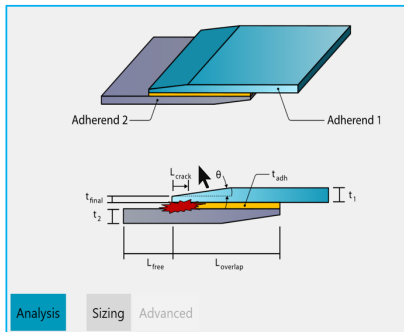

Impact damage on laminate causing barely visible damage but significant loss in residual strength

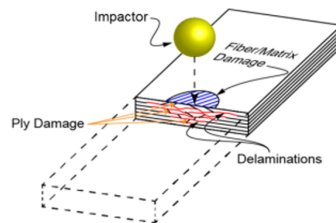

Fig. 12, Damage scenarios can rapidly be analyzed and mitigated in the sizing process.

As a stress framework other preprocessing duties to provide are a material database to maintain properties and allowables; automation FEA load extraction, transformation, and processing including filtering and identification of critical conditions, sizing of metal and composite structure, both stiffened and unstiffened; global FEM management, updating the model's properties; iteration with FEA for load path convergence, deflection limits, and global buckling requirements; and display of data for a user to be able to interpret results, to confirm results, and to spot outliers.

Figure 12 illustrates different ways the rapid tools quantify damage scenarios. Many factors come into play for certification. An essential aspect of dependable quality of results is premised on the accuracy of data input. From experience, a more frequent cause of analysis inaccuracy by a practicing stress engineer is not the method itself, but the selection and use of data to drive it. A framework protects data flow so that the same approved input, for data crack growth allowables like G_{Ic} and G_{IIc} is being used by all analyses. Separate execution opens the door for inconsistent use of input data.

Therefore a primary duty for a framework is to be able to provide one source of truth of data input to be used for ‘unified’ analysis, such as an in-situ material allowable used and the pedigree, the rationale and proof of this value to represent the manufactured part.

The same need exists for one source of design-to loads that are used by all of the analyses. Engineers must be able to trace every step of the way, connect all of the dots from the FEA solution to the loads (forces and moments) applied to their parts, and to know that the loads are consistently applied for all analysis method. In this regard engineers have to be able to select and customize the way in which the FEA computed internal loads are extracted. And to show certification authorities like FAA how this is done. Whether if it’s a peak loads approach, a load averaging approach, a loads enveloping approach, or any other of the multitude of other techniques the engineer chooses and ultimately defends. The framework will trace this data trail through every step of the intermediate calculations all the way to the end for margin of safety.

C. Value of Testing: Calibration Factors

The data presented in Table 1, and then in more detail in Tables 2, 3, and 4 for bonded joints is for the purpose of providing insight for an engineer to achieve structural integrity to their own level of conservatism. Data such as presented in the tables may be used as a guide to select their appropriate conservative factors, or knockdown factors to the analysis.

Keeping in mind that test data provides two important insights. The first which is more commonly understood is accuracy of the method and the tool that implements it. The second is that if a lot of data scatter exists, it’s not so much an analysis accuracy issue, as it’s an issue with being able to consistently fabricate your part.

In the case of bonded joints, a tweaked process to establish a repeatable bond line quality based on a refined and controlled manufacturing process goes a long way toward certification. As a manufacturer, after generating your own in-situ data to quantify expected variability in joint performance, you could evaluate your product’s expected low or high scatter, in which case, use an appropriate KD to achieve confidence.

D. Sizing Joints

Joint sizing is not usually motivated to reduce weight, but rather to resolve negative margins based on the engineer’s preferred sequence of variables to change to achieve a positive margin. The way in which an engineer finds a joint design to carry all loads is very much dependent on a need for design consistency across a structure, and/or available fasteners from a supplier, etc. Another need is a capability to trade between bonded or fastened joints without remodeling or having to modify the GFEM, and to know that the FEA load extraction is performed consistently to insure an apples to apples comparison.

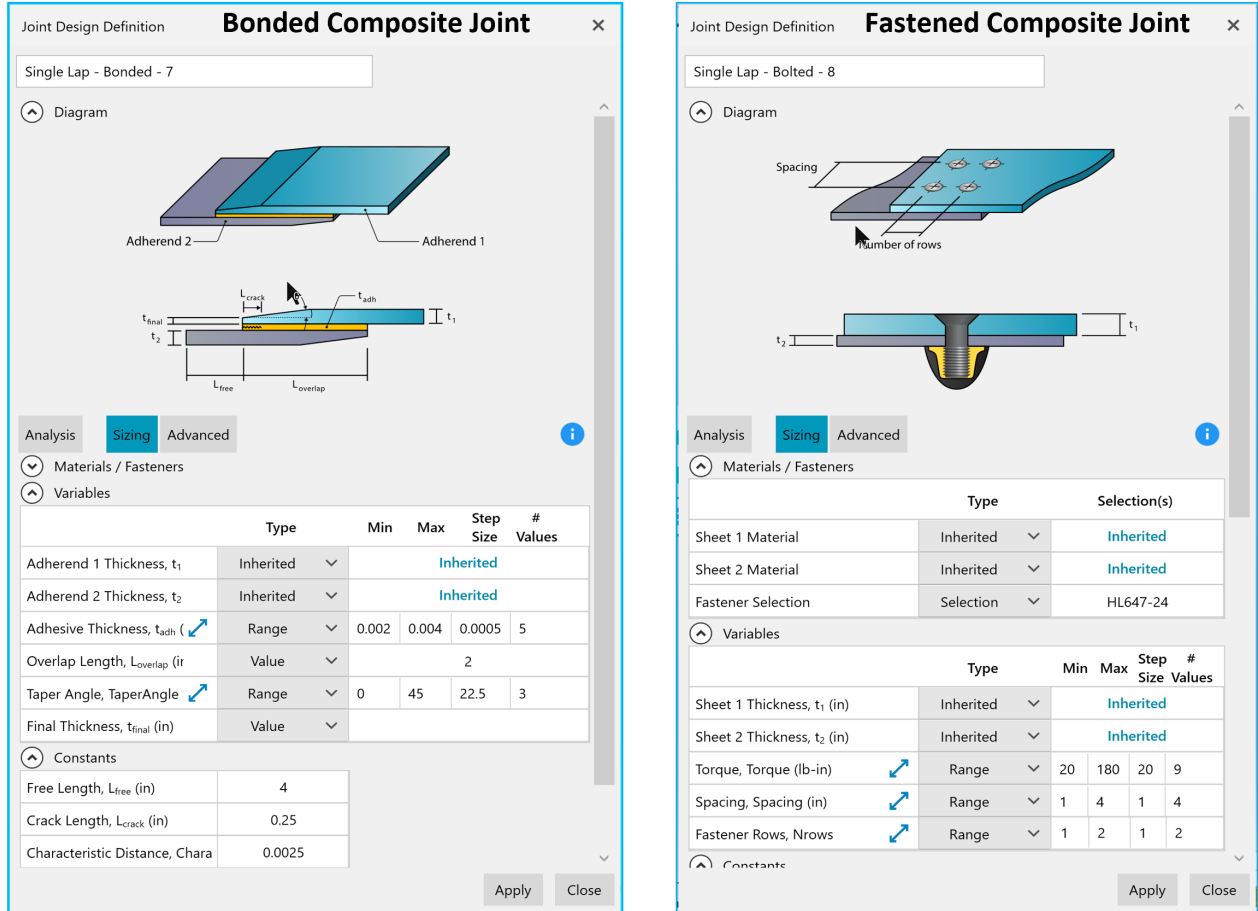

Fig. 13, Sizing Bonded and Fastened Joint variables to optimize can be sequenced by priority.

E. Sizing Panels

Panels cover the acreage surface areas of an airframe. As such their weights contribute substantially to the airframe's overall structural weight. Sizing them to be lighter is a high motivation for the engineer, figure 14.

F. Sizing Laminates

Different laminate optimization approaches were used on sizing the fuselage-wing. These include hat and I shaped non-parametric rapid sizing, parametric detail sizing, ply count effective laminate sizing, discrete ply stacking laminate sizing, and sizing using predefined laminate families (defined with spreadsheets). Laminate family sizing is less weight optimum but makes the sequencing of plies easier since there is less variability in optimized laminates across zone neighbors. This was the method used for the ply definitions in figure 15.

Design fidelity is as important as the analysis fidelity and they go hand in hand as the trade studies progress. For instance, a composite design may be based simply on ply counts. That is the number of plies in the 0/45/90 directions. Which is the same as knowing the total laminate thickness and the ply % in the 0/45/90 directions. At this design phase, for some analysis methods, accuracy can be significantly effected. An example is skin buckling between stiffeners. Actual ply-by-ply stacking is necessary to quantify the bending stiffnesses $[D]$. These bending stiffnesses significantly influence the buckling load prediction. Without the actual stacking, smeared homogenous D_{ij} stiffness

terms would be calculated that very likely are quite different than actual values that represent a design, and hence cause incorrectly reported margins.

Design Definition

Fuselage Agerage (Hat-Bonded) 01

Material Mode Metal Laminate Any

Mode Element Sizing Rapid Sizing Detailed Sizing Final Analysis

Req. Designs 1 # Candidates 42300

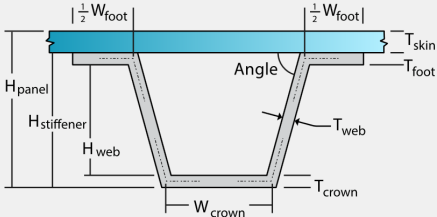

Dimension	Min	Max	Steps	Step Size	Material
T _{skin} (in)	0.064843	0.73488	94		{94 discrete laminate candidates}
T _{web} (in)	0.093661	0.093661	1		{1 discrete laminate candidate}
T _{foot} (in)	0.093661	0.093661	1		(Determined by the web variable's material)
T _{crown} (in)	0.093661	0.093661	1		(Determined by the web variable's material)
H _{stiffener} (in)	0.75	2.25	3	0.75	
Spacing (in)	8	12	5	1	
Angle (°)	60	75	3	7.5	
W _{foot} (in)	1	2	2	1	
W _{crown} (in)	0.5	1.8	5	0.325	
H _{panel} (in)	(Dependent variable)				
H _{web} (in)	(Dependent variable)				
W _{open} (in)	(Dependent variable)				

Design Criteria ▾

Apply Close

Fig. 14, Sizing a Hat Stiffened Panel

The image of figure 15 is included to show the value of a laminate stacking visual cut plane. The engineer can see the actual ply stacking being analyzed anywhere on the structure. This location represents a design perhaps not as light weight as possible, but at least one that is mature and ready to go from ply optimized boundaries, to laminate staggered ply boundaries. More importantly it provides the engineer with the knowledge of the state of the design and to know discrete ply stacking is known and should be used by his analysis tools. And that the same composite data, via the framework, is going into each analysis tool.

Another benefit of the visual display is that it allows the engineer to inspect. In this case there is a possible problem here at the hole that would benefit from ESDU 91003 best practices for interleaving ply drops, which reduces the number of plies dropping consecutively.

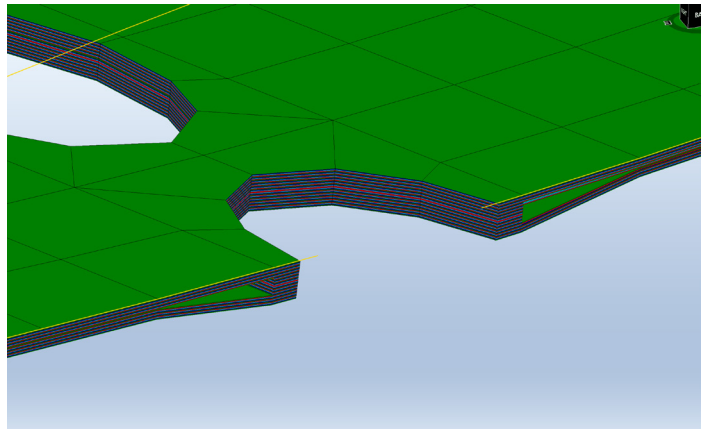

Fig. 15, Laminate ply sequencing using laminate family spreadsheet definitions.

IX. Jet Engine IFS

A. CAI Rapid Tool

UTRC and Collier separately executed the 2C20 CAI/BVID rapid tool within the framework to generate damage BVID laminate strengths for small diameters of approximately 0.5", 1.0", and 1.5". UTRC chose the AS4/8552 tape material and Collier selected IM7/8552 tape. For each material system, correction factors were determined to multiply by pristine allowables to arrive at CAI allowables. For the IM7/8552 tape, hard, quasi isotropic, and soft laminates ply % allowables were generated for the three damage scenarios.

The CAI corrected allowables were then used by UTRC and by Collier to perform failure analysis and sizing of this structure using the stress engineering process framework.

In summary, without testing by using the UTRC impact simulation software tool to predict damage size from impact energies, and then the resulting CAI residual strength of the composite material, the sandwich panel zones are analyzed and optimized. Optimum core thickness and density, as well as the laminate thickness, percent plies in the 0/45/90 directions, and the discrete ply stacking order is discovered that achieves positive margins to three defined load cases and to the three defined impact scenarios. For IM7/8552 damage diameters of 0.5", 1.0", and 1.5" produce weight gains of 49%, 59%, and 76% respectively.

B. Designing for Manufacturing with Automated Fiber Placement (AFP)

The double curvature shape of this structure lends itself well to manufacturing challenges, particularly when fabricated using AFP. Robotic AFP manufacturing produces a part that is not the ideal stress analyst's laminate. For this reason, this structure was used to demonstrate tools developed both in 2c20 rapid tools and 2c22 design for manufacturing NASA ACC Cooperative Research Teams. The Collier provided FEM will be used to show synergistic value in tying together the data flow between the analysis and manufacturing technologies as well as benefits to improved analysis accuracy for certification that also results in a more consistent part with less AFP related defects.

Specifically quantifying undesirable design features (defects) via simulation (using the VCP software from CGTech) of the expected fiber paths of production parts is in the HyperSizer analysis and laminate optimization. This includes deviation of the true fiber path from the intended reference path as idealized in the FEM, and individual ply laps and gaps as well as their buildup of laminate thickness variation. Connecting to the 2C22 Design for Manufacturing CRT developed Central Optimizer. Figure 16 illustrates the process.

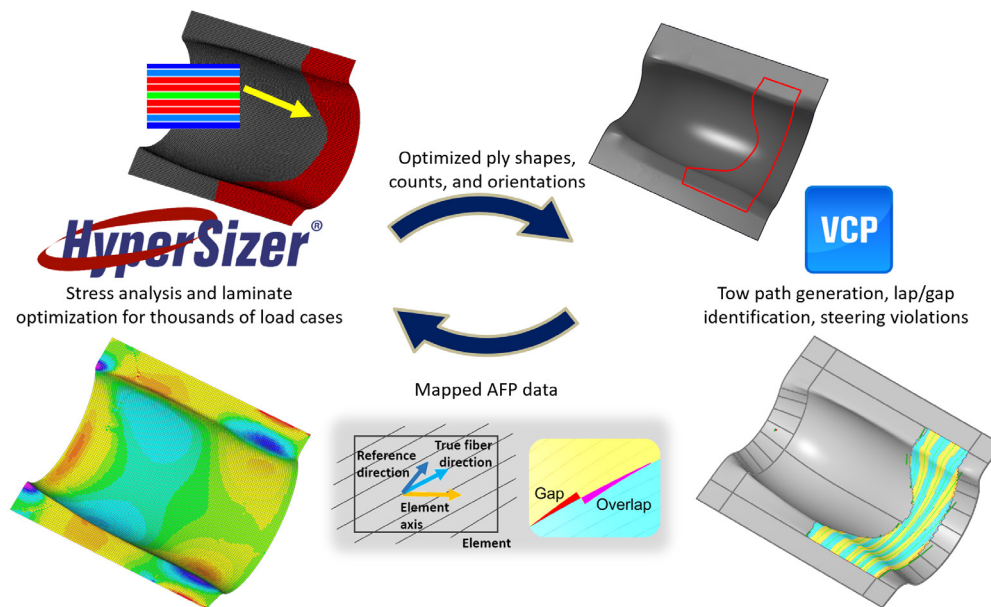

Fig. 16, AFP Central Optimizer Process

The plies from each sizing zone were assembled into “global” plies by HyperSizer’s sequencing routine. These global plies become the plies for manufacturing. There are 31 global plies in total. An example of some of these plies are shown in 17 and 18.

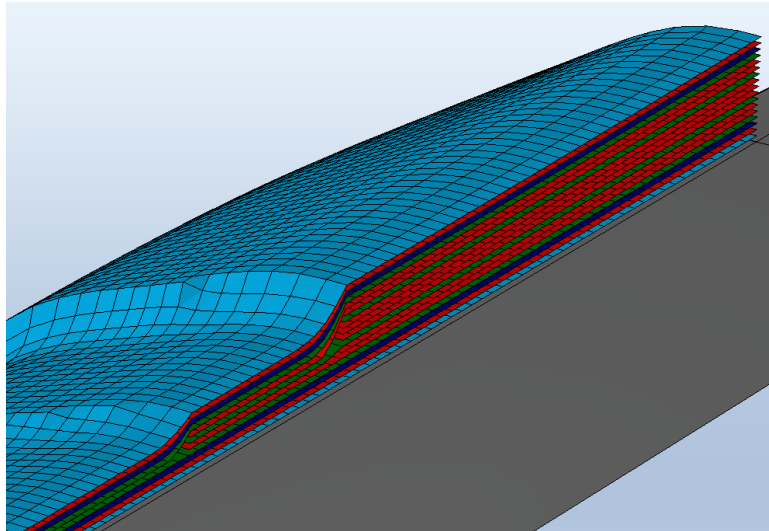

Fig. 17, Optimized plies viewed from edge of part in HyperSizer.

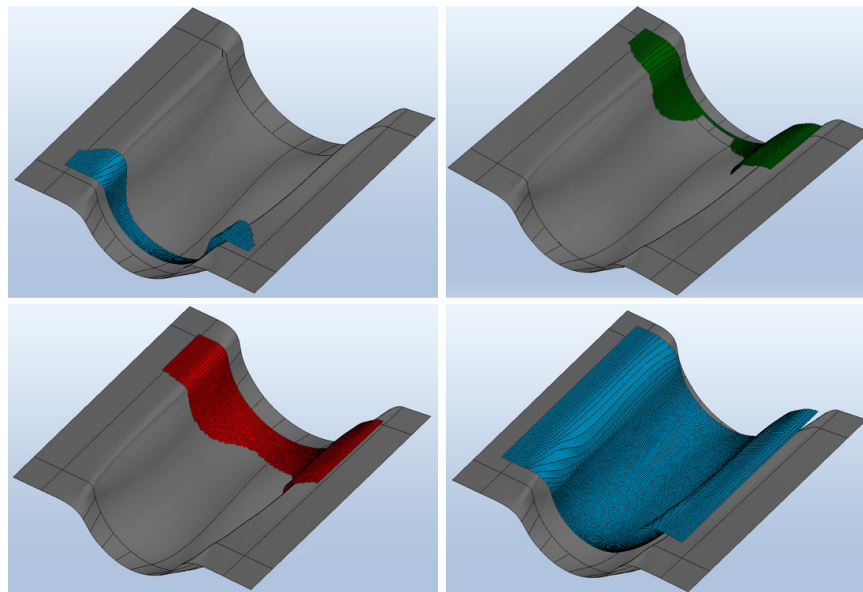

Fig. 18, Example global ply shapes from HyperSizer.

i. Generation of AFP Data in VCP

The next step was the generation of AFP data with VCP. The HyperSizer global plies were first transferred to the CATIA composites workbench using the HyperSizer data export. In CATIA, the ply definitions were translated from a FEM format to a CAD format. The plies were then exported to VCP for tow path generation. The exported data included ply boundaries and orientations.

With this data in VCP, tow paths were generated for each ply. The latest version of VCP has a batch functionality (added over the course of the 2C22 project) to automatically generate the tow paths without user intervention. An example of the AFP tow paths is shown in figure 19.

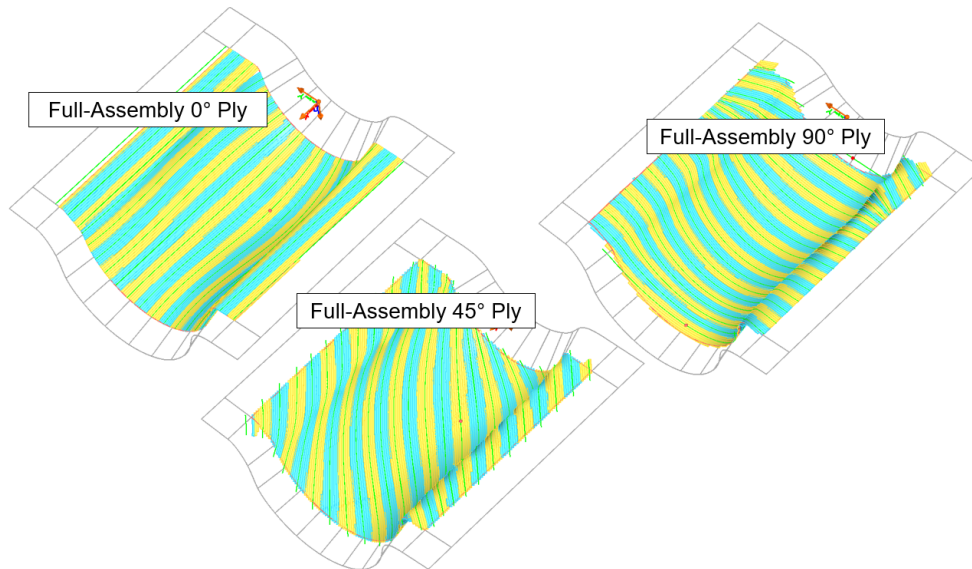

Fig. 19, Example tow paths generated in VCP for the IFS.

Once the tow paths were generated for each ply, the data was exported with VCP's batch functionality. The format of the data export was customized to be mapped to the Central Optimizer and HyperSizer. The exported data includes:

- Fiber directions for each FEM element, for each ply
- Lap and gap data for each ply
 - Polylines around feature perimeters
 - Statistics of all features: length, width, area
- Course centerlines for each ply

ii. Importing AFP Data into Central Optimizer and HyperSizer

The VCP data described above was imported into the Central Optimizer and HyperSizer for evaluation and inclusion in the stress analysis. The AFP fiber directions were the first portion of data imported. The imported data provides a fiber direction per element, per ply, which can be used to determine how much the as-manufactured fiber direction deviates from the rosette fiber orientations assumed on the FEM. The fiber directions imported from VCP are shown in figure 20 with the AFP course centerlines overlaid on the model. In the red box area deviations are slight, and more significant in other areas.

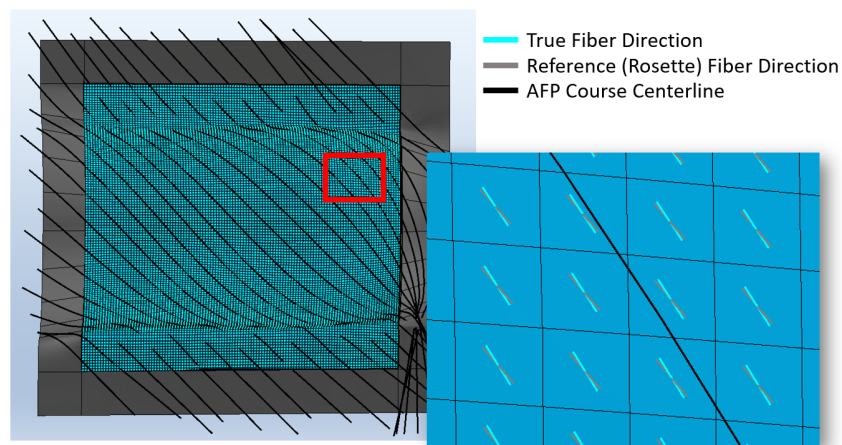

Fig. 20, AFP fiber direction data for -45degree ply.

The fiber direction update caused some of the strength margins to become negative at the rear lip of the FEM. The changes in strength margins become more evident when plotting delta between the updated and original margins. Figure 21 shows this delta (positive delta indicates the margin *improved* after including AFP fiber directions, negative delta indicates the opposite). Although some elements have a very large reduction in strength margin, they happened to be elements that already had a very high strength margin, so no corrective action would be needed. This type of information is one of the key benefits provided by the Central Optimizer and HyperSizer analysis workflow.

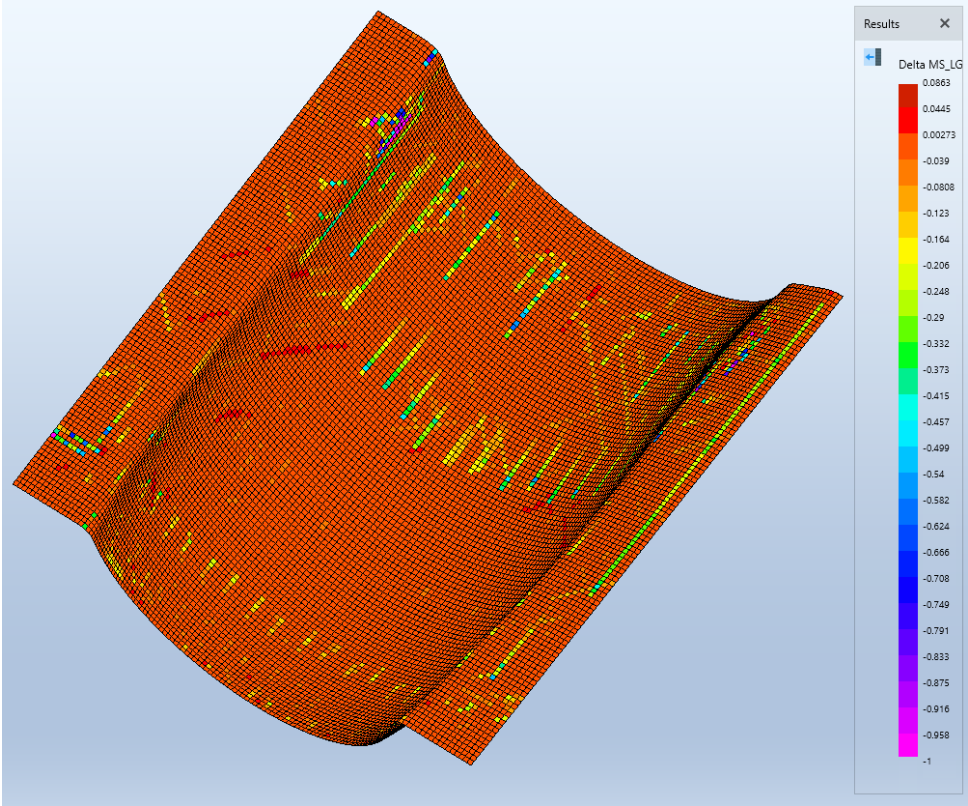

Fig. 21, Delta strength margins for inclusion of laps and gaps in analysis, yellow is more detrimental change.

X. Conclusion

Two analysis tools were developed and implemented into the HyperSizer stress framework as plugins under the ACC project, while an additional two, which had been previously developed, were enhanced. A rapid bonded joint analysis methodology was enhanced to enable better visualization of results and location on a GFEM, and sizing capability was added to aid engineers in determining appropriate geometric and material parameters. A postbuckling capability based on a converged, iterated von Kármán effective width approach was also enhanced to increase traceability of results. All four rapid tools were verified and test data validated, Table 1.

The stress framework was evaluated by industry partners and NASA to estimate the reduced design and analysis cycle time by using these tools integrated in the framework rather than as their standalone counterparts. The ACC members used the stress framework on representative aerospace models, figure 1, with hundreds of unique load cases, to size panel and joint cross-sections while using all rapid tools together in a unified analysis process.

ACC developed and verified & validated small damage CAI and large notch 2Bay Crack rapid tools are available to ACC members standalone and integrated in the framework for future use. The ACC verified & validated Bonded Joint and Postbuckling tools are available today commercially in the framework.

A. Author's commentary

A stress analyst's product should not be thought of as only establishing that a structure can carry a prescribed load, giving a "go" or "no-go" to a design. Rather the expertise of the stress analyst should also be realized in the product's decision making process – to provide meaningful insight for high level decisions. Decisions that will affect the product's ability to be certified, to be consistently manufactured, and to be maintained over the life cycle. It is this objective the HyperSizer stress framework is also addressing.

Acknowledgments

The material is based upon work supported by NASA under Award Nos. NNL09AA00A and 80LARC17C0004. Any opinions, findings, and conclusions or recommendations expressed in this material are those of the author(s) and do not necessarily reflect the views of the National Aeronautics and Space Administration. The authors acknowledge UTRC for assistance in implementing the rapid BVID / CAI strength model into the framework, Spirit AeroSystems for sharing their FEMs and expertise in AFP fuselage manufacturing, NIAR for testing, and the other ACC team members Boeing, Aurora, Northrop Grumman Innovation Systems, USC McNAIR Center, and NASA for their technical support and evaluation of the HyperSizer stress framework.

References

- [1] T. v. Kármán, "The Strength of Thin Plates in Compression," ASME Transactions, vol. 54, no. 2, pp. 53-57, 1932.
- [2] J. Kaczkowski, "New tools for designing flight vehicle structures," in 4th MSC User Polish Conference, Warsaw, 1999.
- [3] C. Collier, P. Yarrington, P. Gustafson and B. Bednareyk, "Local Post Buckling: An Efficient Analysis Approach for Industry Use," in AIAA/ASME/ASCE/AHS/ASC Structures, Structural Dynamics, and Materials Conference, Palm Springs, 2009.
- [4] P. Yarrington, J. Zhang and C. Collier, "Failure Analysis of Adhesively Bonded Composite Joints," in AIAA/ASME/ASCE/AHS/ASC Structures, Structural Dynamics, and Materials Conference, Austin, 2005.
- [5] S. P. Jones, B. Stier, B. A. Bednareyk, E. J. Pineda and U. R. Palliyaguru, "Verification, Validation, and Limits of Applicability of a Rapid Bonded Joint Analysis Tool," in AIAA/ASME/ASCE/AHS/ASC Structures, Structural Dynamics, and Materials Conference, Orlando, 2020 (to be published).
- [6] Collier Research Corporation, "HyperSizer Pro," [Online]. Available: <http://hypersizer.com/pro/>
- [7] Collier Research Corporation, "Methods & Equations Joint Strength, Composite Bonded," 28 May 2005. [Online]. Available: http://hypersizer.com/download.php?type=analysis&file=AID160-180_Joint_Strength,_Composite_Bonded.HME.pdf.
- [8a] Collier Research Corporation, "Postbuckling," [Online]. Available: https://hypersizer.com/help_7.3/#StressAnalysis/pb-about.php.

- [8b] C. Collier, P. Yarrington and B. Van West, "Composite, Grid-Stiffened Panel Design for Post Buckling Using HyperSizer," in AIAA/ASME/ASCE/AHS/ASC Structures, Structural Dynamics, and Materials Conference, Denver, 2002.
- [9] J. Zhang, B. A. Bednarczyk, C. Collier, P. Yarrington, Y. Bansal and M.-J. Pindera, "3D Stress Analysis of Adhesively Bonded Composite Joints," in AIAA/ASME/ASCE/AHS/ASC Structures, Structural Dynamics, and Materials Conference, Austin, 2005.
- [10] F. Mortensen and O. T. Thomsen, "Analysis of Adhesive Bonded Joints: A Unified Approach," *Composites Science and Technology*, vol. 62, no. 7, pp. 1011-1031, 2002.
- [11] Collier Research Corporation, "Stress Framework - HyperSizer," 2018. [Online]. Available: <https://hypersizer.com/stress-framework/>
- [12] L. B. Borkowski, R. S. Kumar and U. R. Palliyaguru, "Mechanics-based Modeling Approach for Rapid Prediction of Low Velocity Impact Damage in Composite Laminates," in AIAA/ASME/ASCE/AHS/ASC Structures, Structural Dynamics, and Materials Conference, Orlando, 2020 (to be published).
- [13] Borkowski, L., & Kumar, R. S. (2018a). Rapid Analysis Method for Composite Compression after Impact Strength Prediction. In 2018 AIAA/ASCE/AHS/ASC Structures, Structural Dynamics, and Materials Conference (p. 0484).
- [14] P. Enjuto, M. Lobo, T. H. Walker, G. Pena, E. Cregger and S. P. Wanthal, "Investigation of Stiffening Effects on Notch Growth Trajectory of Composite Stiffened Panels with Large Transverse Notches," in AIAA/ASME/ASCE/AHS/ASC Structures, Structural Dynamics, and Materials Conference, San Diego, 2019.
- [15] T. H. Walker, L. B. Ilcewicz, D. R. Polland and C. J. Poe, "Tension fracture of laminates for transport fuselage. Part 2: Large notches," in NASA Advanced Composites Technology Conference, Long Beach, 1993.



December 31, 2019

RE: Reserved Rights Statement

Dear AIAA,

Regarding the following attached AIAA conference paper:

“Unified Analysis of Aerospace Structures through Implementation of Rapid Tools into a Stress Framework” Craig S. Collier and Stephen P. Jones, Copyright Collier Research & Dev Corp 2019,

Collier Research and CRT members reserve the rights to duplicate, and reuse material and content in full or in part and make derivatives works thereof. Furthermore, NASA contract NNL09AA00A provides Cooperative Research Team Members certain rights including but not limited to a non-exclusive, irrevocable, royalty-free, paid-up, worldwide license, including a license to use, reproduce, make derivative works thereof. Cooperative Research Team members include:

- Collier Research and Development Corporation
- National Aeronautics and Space Agency (NASA)
- The Boeing Company
- United Technologies Corporation
- Aurora Flight Sciences Corporation
- Spirit AeroSystems, Inc.
- ATK Space Systems, Inc.
- University of South Carolina
- Wichita State University

A handwritten signature in black ink that reads "Ivonne M. Collier".

Ivonne Collier
Vice President
Collier Research Corporation
ivonne@Hypersizer.com



760 Pilot House Drive, Ste. A • Newport News, VA 23606
Voice • 757.825.0000 Fax • 757.825.9988
Hypersizer.com • email: info@hypersizer.com